

COUNTER/TIMER

DIN size W72 × H72, W48 × H96, W144 × H72mm COUNTER/TIMER

■ Features

- Easy to select 36 kinds of input operation mode or 20 output operation modes by internal DIP switch.
- Counting speed Up grade :
1cps / 30cps / 2kcps / 5kcps
- Wide range of input power supply :
100–240VAC 50/60Hz, 12–24VDC (Option)
- Build-in a micro computer
- Display the set function of decimal point



⚠ Please read "Caution for your safety" in operation manual before using.



■ Specifications

※ Blacked(■) items are upgraded function.

Model	Single preset	FX4	FX6	FX4H	—	—
	Double preset	FX4-2P	FX6-2P	FX4H-2P	FX4L-2P	FX6L-2P
	Indication	FX4-I	FX6-I	FX4H-I	FX4L-I	FX6L-I
Digit		4	6	4	4	6
Digit size		W8×H14mm	W4×H8mm	W6×H10mm	W8×H14mm	
Power supply		100–240VAC 50/60Hz, 12–24VDC (option)				
Allowable voltage range		90 ~ 110% of rated voltage				
Power consumption		<ul style="list-style-type: none"> • Indication : Approx. 6VA (240VAC 60Hz), Approx. 2.7W (24VDC) • Single preset : Approx. 7VA (240VAC 60Hz), Approx. 3.3W (24VDC) • Double preset: Approx. 8VA (240VAC 60Hz), Approx. 3.8W (24VDC) 				
Max. counting speed for CP1, CP2		1cps/30cps/2kcps/5kcps selectable by internal DIP switch				
Min. input signal width	RESET input	Approx. 20ms				
	INHIBIT input					
Input	CP1, CP2 input (INHIBIT)	Input logic is selectable [Voltage input] Input impedance : 5.4kΩ, "H" level : 5–30VDC, "L" level : 0–2VDC [No-voltage input] Impedance at short-circuit : Max. 1kΩ, Residual voltage at short-circuit : Max. 2VDC, Impedance at open-circuit : Max. 100kΩ				
	RESET input					
One-shot output time		1st. output : 0.5sec				
		2nd output : 0.05~5sec				
Control output	Contact	Type	Single preset type : SPDT(1c), Double preset type : 1st output SPDT(1c), 2nd output SPDT(1c)			
		Capacity	250VAC 3A at resistive load			
	Solid-state	Type	Single preset type : 1 NPN open collector Double preset type : 1st output 1 NPN open collector, 2nd output 1 NPN open collector			
		Capacity	30VDC Max. 100mA Max.			
Memory retention		10 years (when using non-volatile semiconductor memory)				
External sensor power		12VDC ± 10% 50mA Max.				
Ambient temperature		–10 ~ +55°C (at non-freezing status)				
Storage temperature		–25 ~ +65°C (at non-freezing status)				
Ambient humidity		35 ~ 85%RH				

(A) Counter

(B) Timer

(C) Temp. controller

(D) Power controller

(E) Panel meter

(F) Tacho/Speed/Pulse meter

(G) Display unit

(H) Sensor controller

(I) Proximity sensor

(J) Photo electric sensor

(K) Pressure sensor

(L) Rotary encoder

(M) 5-Phase stepping motor & Driver & Controller

FX/FXH/FXL SERIES

Specifications

Insulation resistance	Min. 100MΩ (at 500VDC)				
Dielectric strength	2000VAC 50/60Hz for 1 minute				
Noise strength	AC power	±2kV the square wave noise(pulse width:1μs) by the noise simulator			
	DC power	±500V the square wave noise(pulse width:1μs) by the noise simulator			
Vibration	Mechanical	0.75mm amplitude at frequency of 10 ~ 55Hz in each of X, Y, Z directions for 1 hour			
	Malfunction	0.5mm amplitude at frequency of 10 ~ 55Hz in each of X, Y, Z directions for 10 minutes			
Shock	Mechanical	300m/s ² (Approx. 30G) in X, Y, Z directions for 3 times			
	Malfunction	100m/s ² (Approx. 10G) in X, Y, Z directions for 3 times			
Relay life cycle	Mechanical	Min. 10,000,000 operations			
	Electrical	Min. 100,000 operations at 250VAC 2A(resistive load)			
Weight	FX4 : Approx. 295g FX4-2P : Approx. 305g FX4-I : Approx. 260g	FX6 : Approx. 305g FX6-2P : Approx. 315g FX6-I : Approx. 265g	FX4H : Approx. 325g FX4H-2P : Approx. 353g FX4H-I : Approx. 297g	FX4L-2P : Approx. 544g FX4L-I : Approx. 455g	FX6L-2P : Approx. 550g FX6L-I : Approx. 461g
	Approval				

※Qualification mark for FX4, FX4-I, FX6, FX6-I.

Connections

●FX-2P

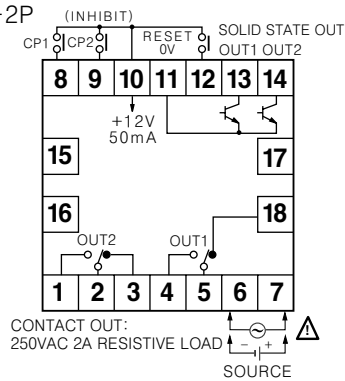

●FX

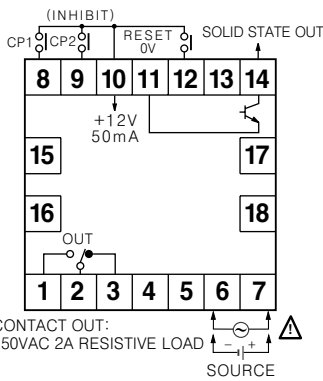

●FX-I

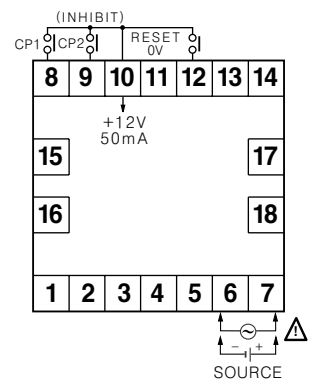

●FXH-2P

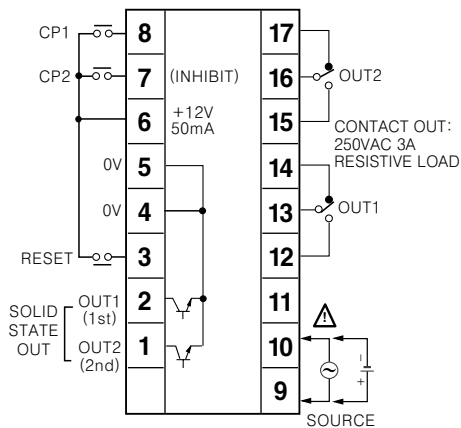

●FXH

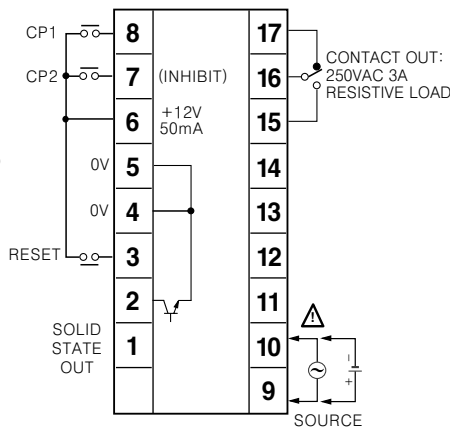

●FXH-I

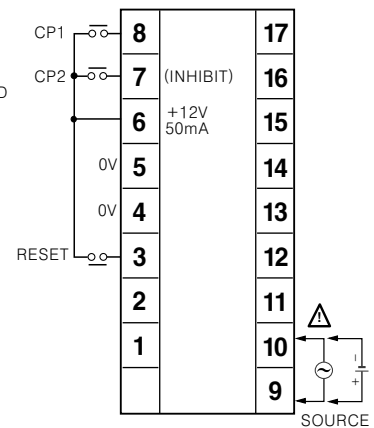

●FXL-2P

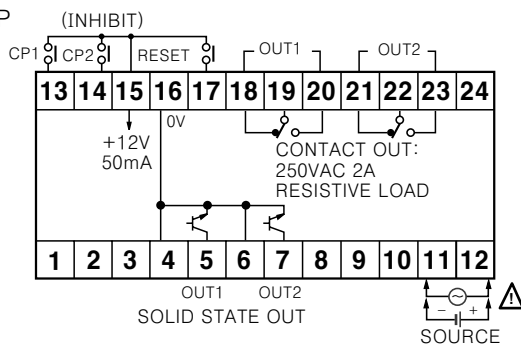

●FXL-I

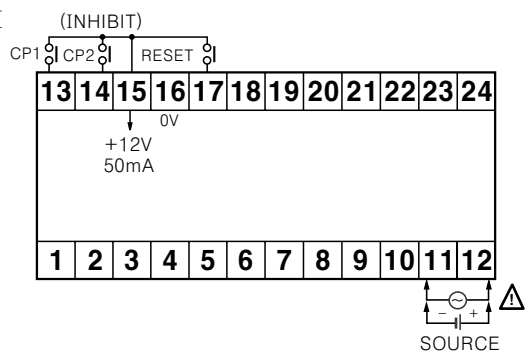

※CP2(INHIBIT) : Time hold terminal when using for timer.
 ※It is operated by power ON start type when using for timer.

COUNTER/TIMER

Dimensions

●FX series

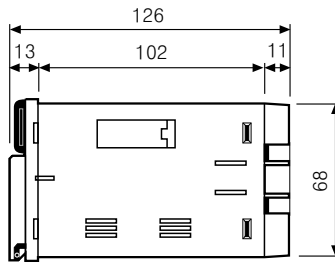
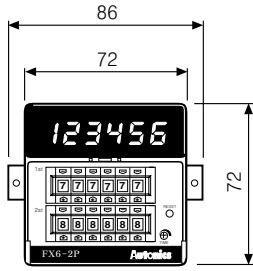

●Panel cut-out

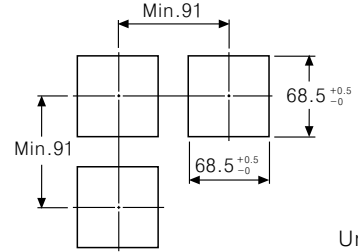

Unit:mm

●FXH series

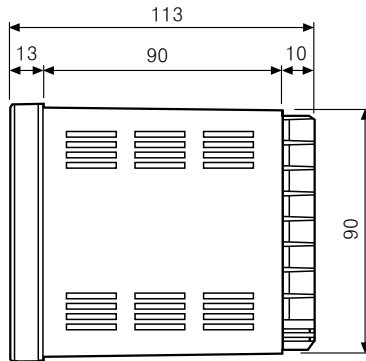
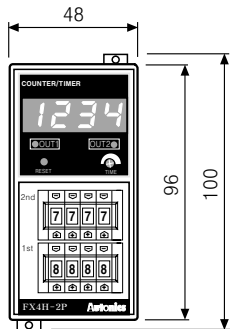

●Panel cut-out

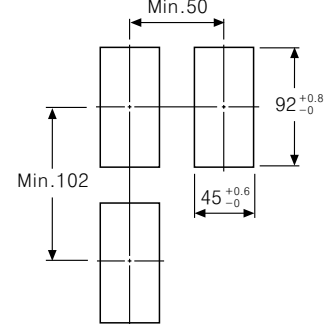

Unit:mm

●FXL series

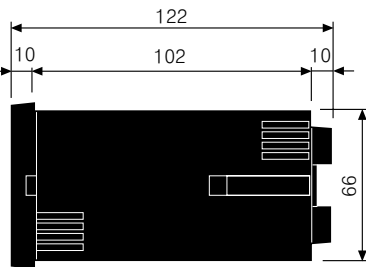
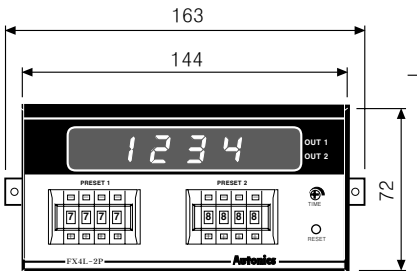

●Panel cut-out

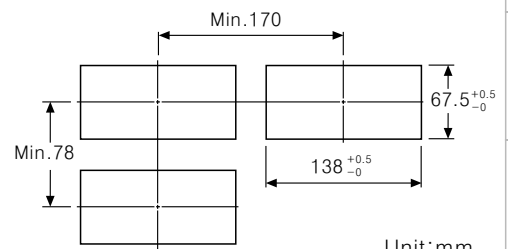

Unit:mm

Input connections

◎Input logic : No-voltage input(NPN)

●Solid-state input(Standard input sensor :NPN output type sensor)

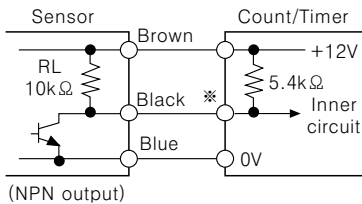

※CP1, CP2(INHIBIT), RESET input

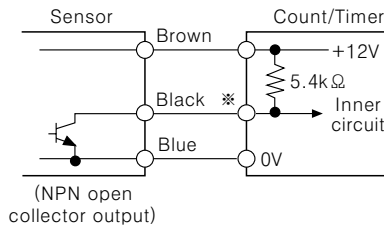

●Contact input

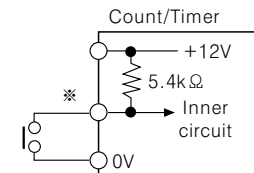

Counting speed :
1 or 30cps setting(Counter)

◎Input logic : voltage input(PNP)

●Solid-state input(Standard input sensor :PNP output type sensor)

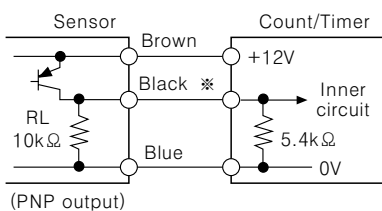

※CP1, CP2(INHIBIT), RESET Input

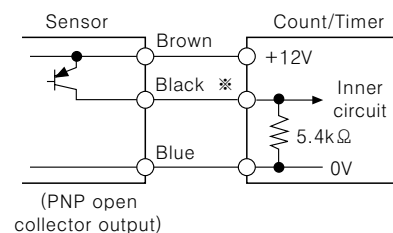

●Contact input

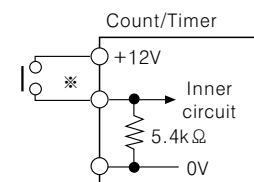

Counting speed :
1 or 30cps setting(Counter)

(A)
Counter

(B)
Timer

(C)
Temp.
controller

(D)
Power
controller

(E)
Panel
meter

(F)
Tacho/
Speed/
Pulse
meter

(G)
Display
unit

(H)
Sensor
controller

(I)
Proximity
sensor

(J)
Photo
electric
sensor

(K)
Pressure
sensor

(L)
Rotary
encoder

(M)
5-Phase
stepping
motor &
Driver &
Controller

FX/FXH/FXL SERIES

Input logic selection

FX series

Input logic is changeable by input logic selection switch located at the one-side of case.

- No voltage input (NPN)
- Voltage input (PNP)

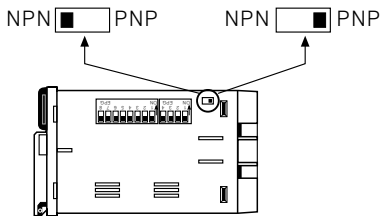

FXL series

Input logic is changeable by input logic selection switch located at the terminal block.

- No voltage input (NPN)



- Voltage input (PNP)



FXH series

Input logic is changeable by input logic selection switch (SW3) located at inside of the case.

- No voltage input (NPN)

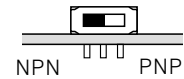

- Voltage input (PNP)

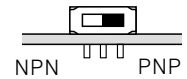

Direction of front display

Direction of front display

*Please be sure to turn power OFF before changing input logic.

Input & output connections

◎In case of operating the load by power supply of the sensor

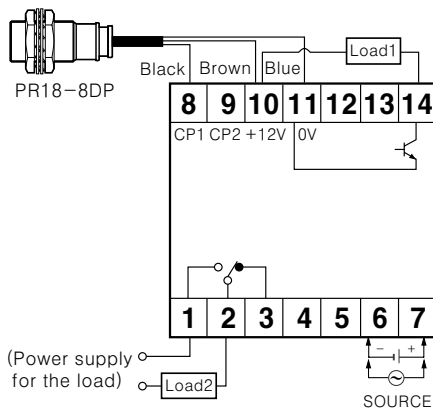

- Please select proper capacity of load, because total value of load capacity and current consumption should not be exceed current capacity (50mA max.).

◎In case of operating the load by external power supply

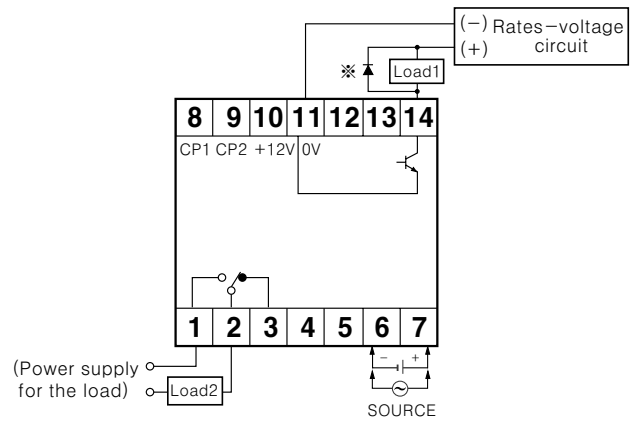

- The capacity of the load must not be exceed max. 30VDC, max. 100mA of the switching capacity of the transistor.
- Please do not supply the reverse polarity voltage.
- *Please connector the surge absorber (Diode, Varistor, etc.) at both terminals of the load, in case of using the inductive load.

◎How to count by external power supply

This unit counting when "H" level (5-30VDC) is applied at CP1 or CP2 ("Low" : 0-2VDC)

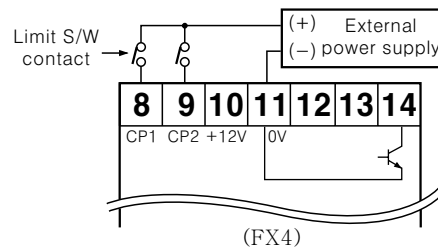

◎Using 2 counters with one sensor

- It is available to use 2 counters with one sensor.
- The power of sensor must be connected to only one of counter.

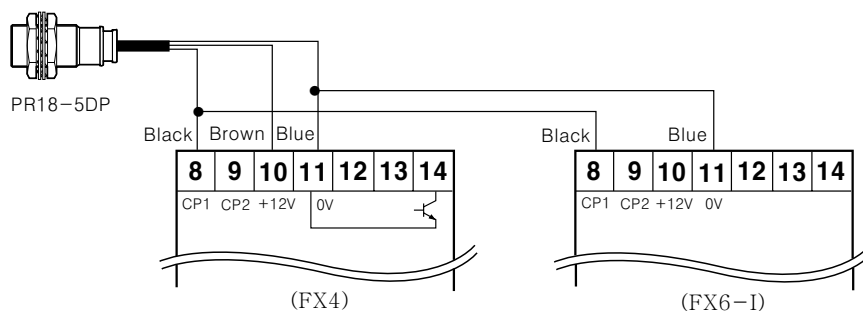

COUNTER/TIMER

■ Selection by DIP switches

● 72×72 DIP switch position

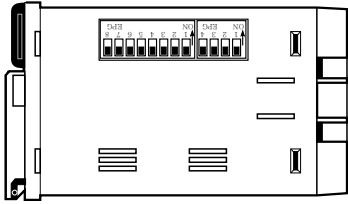

● 48×96 DIP switch position

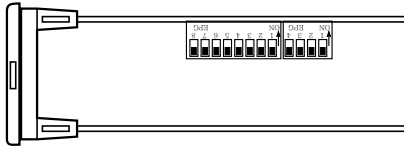

● 144×72 DIP switch position

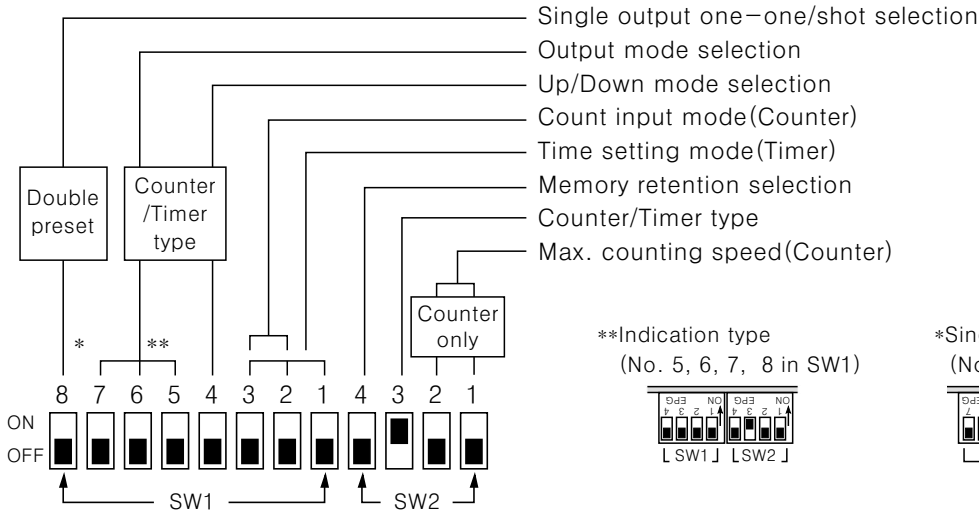
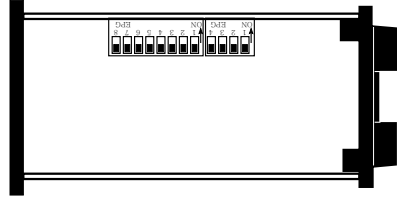

**Indication type (No. 5, 6, 7, 8 in SW1)

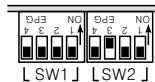

*Single preset (No. 8 in SW1)



● Max. counting speed

SW2	Functions						
<table border="1"> <tr><td>ON</td><td>1</td><td>2</td></tr> <tr><td>OFF</td><td>■</td><td>■</td></tr> </table>	ON	1	2	OFF	■	■	1cps
ON	1	2					
OFF	■	■					
<table border="1"> <tr><td>ON</td><td>1</td><td>2</td></tr> <tr><td>OFF</td><td>■</td><td>■</td></tr> </table>	ON	1	2	OFF	■	■	30cps
ON	1	2					
OFF	■	■					
<table border="1"> <tr><td>ON</td><td>1</td><td>2</td></tr> <tr><td>OFF</td><td>■</td><td>■</td></tr> </table>	ON	1	2	OFF	■	■	2kcps
ON	1	2					
OFF	■	■					
<table border="1"> <tr><td>ON</td><td>1</td><td>2</td></tr> <tr><td>OFF</td><td>■</td><td>■</td></tr> </table>	ON	1	2	OFF	■	■	5kcps
ON	1	2					
OFF	■	■					

● Conter/Timer

SW2	Functions				
<table border="1"> <tr><td>ON</td><td>■</td></tr> <tr><td>OFF</td><td>■</td></tr> </table>	ON	■	OFF	■	Conter
ON	■				
OFF	■				
<table border="1"> <tr><td>ON</td><td>■</td></tr> <tr><td>OFF</td><td>■</td></tr> </table>	ON	■	OFF	■	Timer
ON	■				
OFF	■				

● Up/Down mode

SW1	Functions				
<table border="1"> <tr><td>ON</td><td>■</td></tr> <tr><td>OFF</td><td>■</td></tr> </table>	ON	■	OFF	■	Down mode
ON	■				
OFF	■				
<table border="1"> <tr><td>ON</td><td>■</td></tr> <tr><td>OFF</td><td>■</td></tr> </table>	ON	■	OFF	■	Up mode
ON	■				
OFF	■				

● Memory retention

SW2	Functions				
<table border="1"> <tr><td>ON</td><td>■</td></tr> <tr><td>OFF</td><td>■</td></tr> </table>	ON	■	OFF	■	Power reset (Non memory)
ON	■				
OFF	■				
<table border="1"> <tr><td>ON</td><td>■</td></tr> <tr><td>OFF</td><td>■</td></tr> </table>	ON	■	OFF	■	Memory
ON	■				
OFF	■				

● Selection of one-shot output or hold output for 1st output.

SW1	Function				
<table border="1"> <tr><td>ON</td><td>■</td></tr> <tr><td>OFF</td><td>■</td></tr> </table>	ON	■	OFF	■	1st output : One-shot output
ON	■				
OFF	■				
<table border="1"> <tr><td>ON</td><td>■</td></tr> <tr><td>OFF</td><td>■</td></tr> </table>	ON	■	OFF	■	1st output : Hold output
ON	■				
OFF	■				

※This mode selects a one-shot output(0.5sec fixed) or Hold output(Until 2nd output turns off) for 1st output in the double preset counter.

※Example of F output operation mode

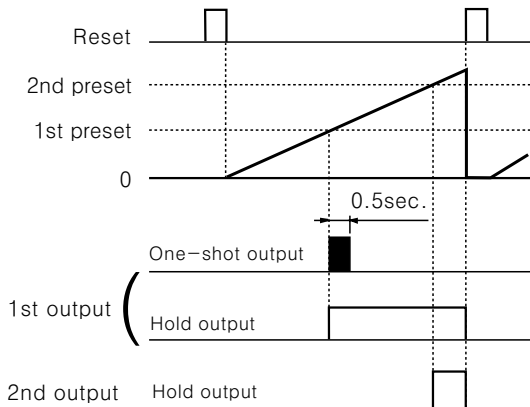

(A) Counter

(B) Timer

(C) Temp. controller

(D) Power controller

(E) Panel meter

(F) Tacho/Speed/Pulse meter

(G) Display unit

(H) Sensor controller

(I) Proximity sensor

(J) Photo electric sensor





(K) Pressure sensor

(L) Rotary encoder

(M) 5-Phase stepping motor & Driver & Controller

FX/FXH/FXL SERIES

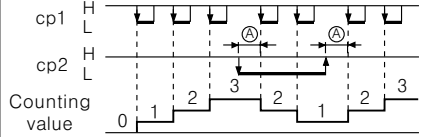
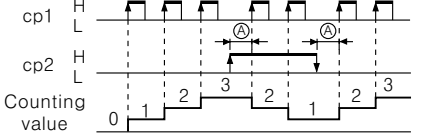
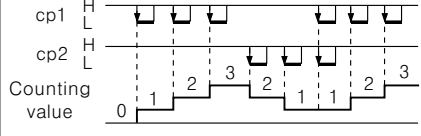
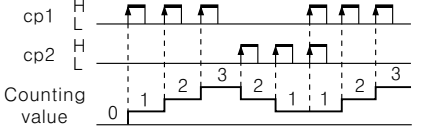
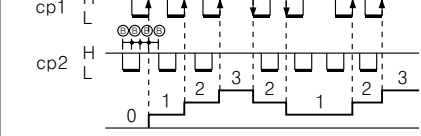
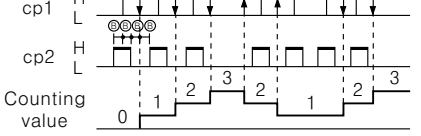
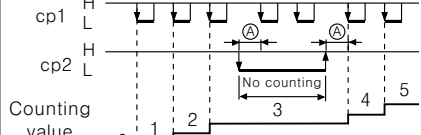
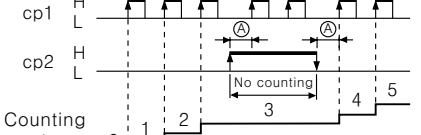
Input operation(Counter)

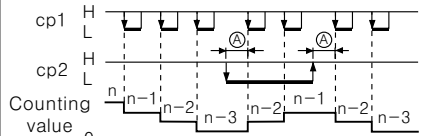
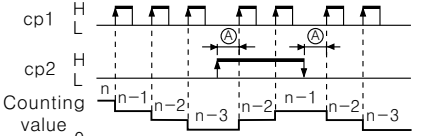
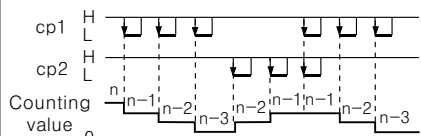
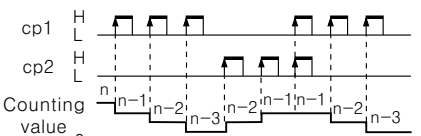
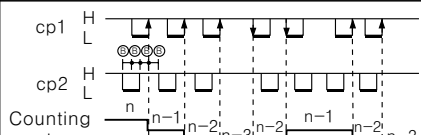
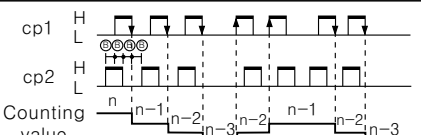
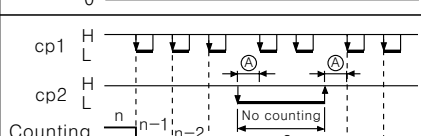
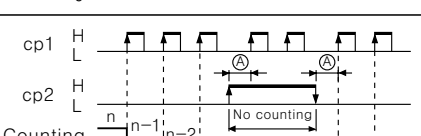
Input mode(SW1)		No-voltage input type(NPN)	Voltage input type(PNP)
Up mode ON  OFF 	Up/Down-A Command input		
	Up/Down-B Individual input		
	Up/Down-C Phase difference input		
	Up Up input		
Down mode ON  OFF 	Up/Down-D Command input		
	Up/Down-E Individual input		
	Up/Down-F Phase difference input		
	Down Down input		

* Ⓐ : Over Min. signal width, Ⓑ : Over 1/2 of Min. signal width.

Counting miss by one(±1)is occurred if the signal width of Ⓐ or Ⓑ is less than min. signal width .

Time setting mode(timer)

	SW1	4Digit	6Digit
A		99.99sec	99999.9sec
B		999.9sec	999999sec
C		9999sec	99min 59.99sec
D		99min 59sec	999min 59.9sec
E		999.9min	99999.9min
F		99hour 59min	99hour 59min 59sec
G		999.9hour	9999hour 59min
H		9999hour	99999.9hour

Counting function(Indication model)

Up mode

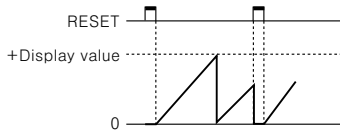

Down mode

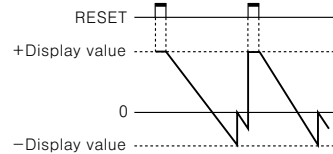

Up / Down-A, B, C mode

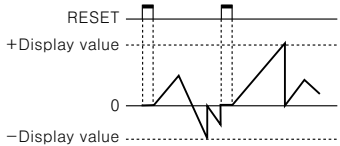

Up / Down-D, E, F mode

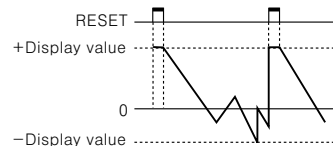

Decimal point setting

Display the decimal point.

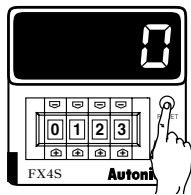

RUN mode

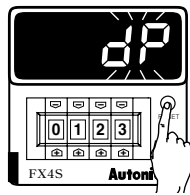

※When "dp" is flickering, one touch the Reset button.

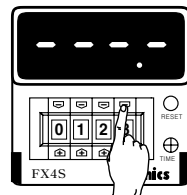

※If pressing one of digital switch buttons (↑, ↓) in decimal point setting mode, decimal point will be moved to Up(+) direction.

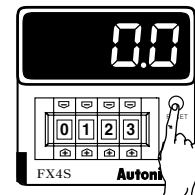

Return to RUN mode

※It returns to RUN mode if pressing RESET button for over 3sec. in decimal point setting status.

Changing the decimal point

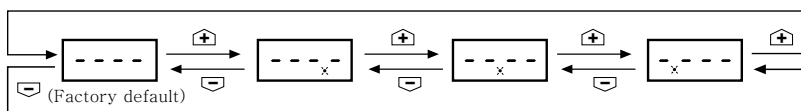

※It returns to RUN mode if no RESET button or digital switch is applied for 60sec. in decimal point setting status.
 ※The decimal point setting is existed in indication type.

(A) Counter

(B) Timer

(C) Temp. controller

(D) Power controller

(E) Panel meter

(F) Tacho/Speed/Pulse meter

(G) Display unit

(H) Sensor controller

(I) Proximity sensor

(J) Photo electric sensor

(K) Pressure sensor

(L) Rotary encoder

(M) 5-Phase stepping motor & Driver & Controller

FX/FXH/FXL SERIES

Output operation mode

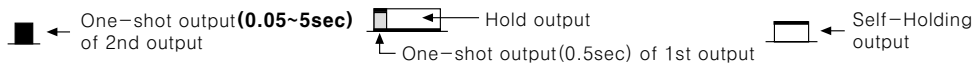

*The output of single preset type is operated at the status of the second output mode

Output mode (SW1)	ON OFF Up mode	ON OFF Down mode	Operation after count up
F	Reset 2nd Preset 1st Preset 0 1st Output 2nd Output	Reset 2nd Preset 1st Preset 0 1st Output 2nd Output	The display value continues until Reset signal applied and the output will be held. • 1st held output and 2nd output will be held until Reset signal applied. • When use 1st output as one-shot output, it will return after operating for 0.5sec.
N	Reset 2nd Preset 1st Preset 0 1st Output 2nd Output	Reset 2nd Preset 1st Preset 0 1st Output 2nd Output	The display value and output will be held until Reset signal.
C	Reset 2nd Preset 1st Preset 0 1st Output 2nd Output	Reset 2nd Preset 1st Preset 0 1st Output 2nd Output	The display returns to initial status and 2nd output will be reset after one-shot time. • 1st hold output will be OFF after one-shot output time of 2nd output. • 1st one-shot output will be reset after operating 0.5sec. not related to 2nd output.
R	Reset 2nd Preset 1st Preset 0 1st Output 2nd Output	Reset 2nd Preset 1st Preset 0 1st Output 2nd Output	The display value will be held until 2nd output is OFF then reset. • 1st hold output will be OFF after one-shot time of 2nd output. • 1st one-shot output will be reset after operating 0.5sec. not related to 2nd output.
K	Reset 2nd Preset 1st Preset 0 1st Output 2nd Output	Reset 2nd Preset 1st Preset 0 1st Output 2nd Output	The display value continues until Reset signal applied. • 1st hold output will be OFF after one-shot time of 2nd output. • 1st one-shot output will be reset after operating 0.5sec. not related to 2nd output.
P	Reset 2nd Preset 1st Preset 0 1st Output 2nd Output	Reset 2nd Preset 1st Preset 0 1st Output 2nd Output	The display value is held during 2nd output one-shot time, counting process is returned to reset start status as soon as 2nd output ON. • 1st hold output will be OFF after one-shot time of 2nd output. • 1st one-shot output will be reset after operating 0.5sec. not related to 2nd output.
Q	Reset 2nd Preset 1st Preset 0 1st Output 2nd Output	Reset 2nd Preset 1st Preset 0 1st Output 2nd Output	The display continues until 2nd output is OFF. • 1st hold output will be OFF after one-shot time of 2nd output. • 1st one-shot output will be reset after operating 0.5sec. not related to 2nd output.
S	Up	Down	<ul style="list-style-type: none"> • Up, Up/Down-A, B, C input mode -OUT1 is ON when (Display value) \geq (1st preset value) -OUT2 is ON when (Display value) \geq (Double preset value) • Down, Up/Down-D, E, F input mode -OUT1 is ON when (Display value) \leq (1st preset value) -OUT2 is ON when (Display value) \leq (Zero)
Counter	Reset 2nd Preset 1st Preset 0 1st Output 2nd Output	Reset 2nd Preset 1st Preset 0 1st Output 2nd Output	
S	Reset 2nd Preset 1st Preset 0 1st Output 2nd Output	Reset 2nd Preset 1st Preset 0 1st Output 2nd Output	When it is used as Timer, 1st output and 2nd output are flickering repeatedly.
Timer	Reset 2nd Preset 1st Preset 0 1st Output 2nd Output	Reset 2nd Preset 1st Preset 0 1st Output 2nd Output	

■ Proper usage

○ Reset

● Reset

In case of changing the input mode after supplying the power, please provide an external reset or manual reset. **If reset is not executed, the counter will be working in previous mode.**

● Reset signal width

To guarantee proper reset, the signal must be supplied for a minimum of **min. 20ms** regardless if the signal comes from a contact or a solid-state input.

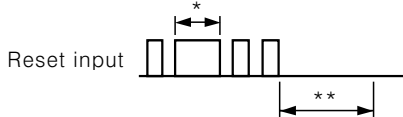

*In case of a contact reset, contact chattering will not affect the reset as long as it is applied for a minimum of 20ms.

**Input signal at CP1 & CP2 must be applied for a minimum of 50ms after the reset is removed.

○ Minimum count signal width

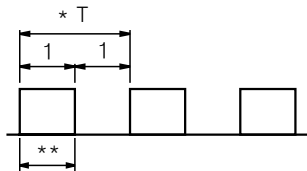

* Assume duty cycle(ON/OFF) of 1:1 period.

**Minimum signal width $\begin{cases} 30\text{cps} : \text{Min. } 16.7\text{ms} \\ 2\text{kcps} : \text{Min. } 0.25\text{ms} \end{cases}$

○ Maximum counting speed

This is the maximum count speed when the duty cycle(ON/OFF) of input signal is 1:1. If duty cycle is not 1:1, the maximum count speed will be slower. The width of ON and OFF signals must always be larger than the minimum signal width.

If either ON or OFF signal is shorter than minimum signal width, this product may not respond.

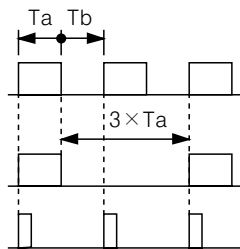

Therefore Ta(ON width) and Tb(OFF width) needed to be over min.signal width.

When duty cycle is 1:3, the maximum counting speed will be $\frac{1}{2}$ from that in our catalog.

This product does not respond.

○ Power

The inner circuit voltage starts to rise up for the first 100ms after power on, the input may not work at this time. And also the inner circuit voltage drops down for the last 500ms after power off, the input may not work at this time.

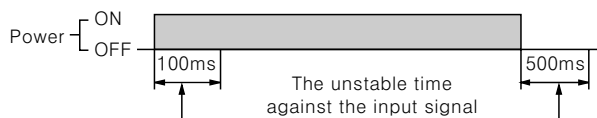

○INHIBIT(Only Timer)

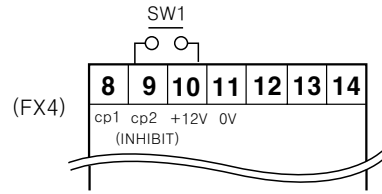

- INHIBIT mode is active when SW1 turns ON. (Time Hold)
- When it is necessary to stop time while the timer is progressing, the INHIBIT mode can be used.
- When the INHIBIT input is turned off, time is progressing again.

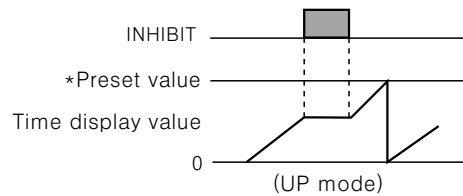

○How to use the sticker

The below sticker can be found inside the box. Use the sticker according to application as follow:

COUNTER	mm	inch	mm	inch
TIMER	m	hour	m	hour
COUNTER	sec	cm	sec	cm
TIMER	min	yd	min	yd

Ex1) Measurement of length by the rotary encoder

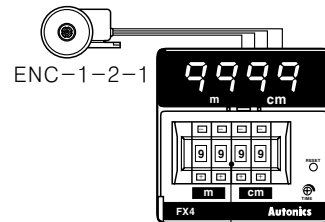

Please put black dot.

EX2)Timer[F mode]

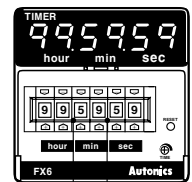

Please put black dot.

○Error display

Error signal	Error description	Returning method
Err0	Zero set state	Change the set value to non zero state

※ There is no Error display function in indication type.

※ When Error is displayed, the output continues OFF state.

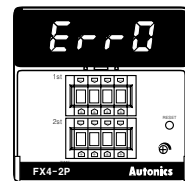
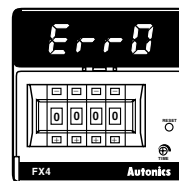

(A) Counter

(B) Timer

(C) Temp. controller

(D) Power controller

(E) Panel meter

(F) Tacho/Speed/Pulse meter

(G) Display unit

(H) Sensor controller

(I) Proximity sensor

(J) Photo electric sensor

(K) Pressure sensor

(L) Rotary encoder

(M) 5-Phase stepping motor & Driver & Controller